



Glensound

EXPRESS *IP*

MKII

**DANTE NETWORK AUDIO
COMMENTATOR UNIT
PRODUCT DETAILS**

6 BROOKS PLACE, MAIDSTONE, KENT, ME14 1HE. ENGLAND.
Visit our Website at www.glensound.co.uk

TEL: +44 (0) 1622 753662
FAX: +44 (0) 1622 762330

Thank you for choosing a new GlenSound product.

All rights reserved.

Information contained in this manual is subject to change without notice, if in doubt please contact us for the latest product information.

If you need any help with the product then we can be contacted at:

GlenSound Electronics Ltd
1 – 6 Brooks Place
Maidstone
Kent
ME14 1HE
United Kingdom

Telephone: +44 (0) 1622 753662

Fax: +44 (0) 1622 762330

EMAIL ADDRESSES

General enquires: office@glenSound.co.uk

Technical enquires: techinfo@glenSound.co.uk

Sales enquires: sales@glenSound.co.uk

PRODUCT WARRANTY

All equipment is fully tested before dispatch and carefully designed to provide you with trouble free use for many years.

We have a policy of supporting products for as long as possible and guarantee to be able to support your product for a minimum of 10 years.

For a period of one year after the goods have been dispatched the Company will guarantee the goods against any defect developing after proper use providing such defects arise solely from faulty materials or workmanship and that the Customer shall return the goods to the Company's works or their local dealer.

All non-wear parts are guaranteed for 2 years after dispatch and any defect developing after proper use from faulty materials or workmanship will be repaired under this warranty providing the Customer returns the goods to the Company's works or their local dealer.



SAFETY WARNING



This product can produce high sound levels via the headphone output.

Please take caution when operating this product as listening to excessively high peak or sustained levels of volume may permanently damage human hearing.



EU DECLARATION OF CONFORMITY FOR:

EXPRESS ^{IP} MKII DANTE NETWORK AUDIO COMMENTATOR UNIT

This declaration of conformity is issued under the sole responsibility of the manufacturer.

This equipment is manufactured by Glensound Electronics Ltd of Brooks Place Maidstone Kent ME14 1HE is  marked and conforms to the following Union harmonisation legislation:

Low Voltage Directive: EN60065 and EN62368-1:2014

Emissions: BS EN55032:2015

Immunity: BS EN55035:2017

Signed for and on behalf of Glensound Electronics Ltd.

Gavin Davis, Managing Director
Maidstone, Kent, England

Date: 28/03/2018

ROHS DIRECTIVE

EC directive 2002/95/EC restricts the use of the hazardous substances listed below in electrical and electronic equipment.

This product conforms to the above directive and for these purposes, the maximum concentration values of the restricted substances by weight in homogenous materials are:

Lead	0.1%
Mercury	0.1%
Hexavalent Chromium	0.1%
Polybrominated Biphenyls	0.1%
Polybrominated Diphenyl Ethers	0.1%
Cadmium	0.01%

WASTE ELECTRICAL AND ELECTRONIC
EQUIPMENT REGULATIONS 2006 (WEEE)

GlenSound Electronics Ltd is registered for business to business sales of WEEE in the UK our registration number is:

WEE/JJ0074UR

GLENSOUND EXPRESS^{IP} MKII MANUAL v3

TABLE OF CONTENTS

PRODUCT WARRANTY	3
EU DECLARATION OF CONFORMITY	4
RoHS DIRECTIVE.....	5
WASTE ELECTRICAL AND ELECTRONIC EQUIPMENT REGULATIONS 2006 (WEEE)	6
GLENSOUND EXPRESS ^{IP} MKII MANUAL v3	7
OVERVIEW.....	8
NEW FOR MKII.....	8
EXPRESS ^{IP} MKII FRONT PANEL LAYOUT	9
EXPRESS ^{IP} MKII REAR PANEL LAYOUT.....	11
SIMPLIFIED BLOCK DIAGRAM	12
CONNECTING THE Express ^{IP} MKII TO A DANTE NETWORK.....	13
Getting Dante Controller.....	13
Connecting Express ^{IP} MKII To the Network	13
Audio Over IP Network.....	13
Running Dante Controller.....	14
Dante Controller TIP	14
Device Not Showing Up In Dante Controller	15
AES67 MODE	16
BUTTON FUNCTIONALITY (see also Interpreter's mode)	19
LED INDICATION OF MODES	19
A & B MIC ON	19
TALKBACK SWITCHES.....	19
INTERPRETER MODE	20
MICROPHONE GAIN.....	21
MICROPHONE GAINS FOR 0dBu OUTPUTS	23
WIRING INFORMATION.....	24
XLR & JACK Wiring.....	24

OVERVIEW

The Glensound Express^{IP} MKII is a two user commentary box providing all of the basic functionality required for two commentators or announcers, where quick and easy setup and operation is important.

It is widely used for sports commentary, reporter interfacing at news events, or for studio based audio translation.

There are four audio inputs into the users' headphones for monitoring, and two talkback circuits. High quality mic amps are used, along with Glensound's Referee compressor/limiter system to help prevent overloading the input circuit.

The Main audio input/output interfacing is provided via the Dante system, allowing uncompressed, low delay audio across networks.

Dante network audio is a common protocol for distributing high quality linear audio over standard IP networks and it is widely used by many audio equipment manufacturers.

The Express^{IP} MKII Dante audio interface is compatible with all Dante audio interfaces across all manufacturers. Further details of Dante network audio can be found at www.audinate.com

As per our other Dante equipment 0dBu = -18dBfs

NEW FOR MKII

The Express^{IP} MKII features two additional audio paths for the commentators, allowing them both to be able to hear each other's mic locally without external mixing.

EXPRESS^{IP} MKII FRONT PANEL LAYOUT

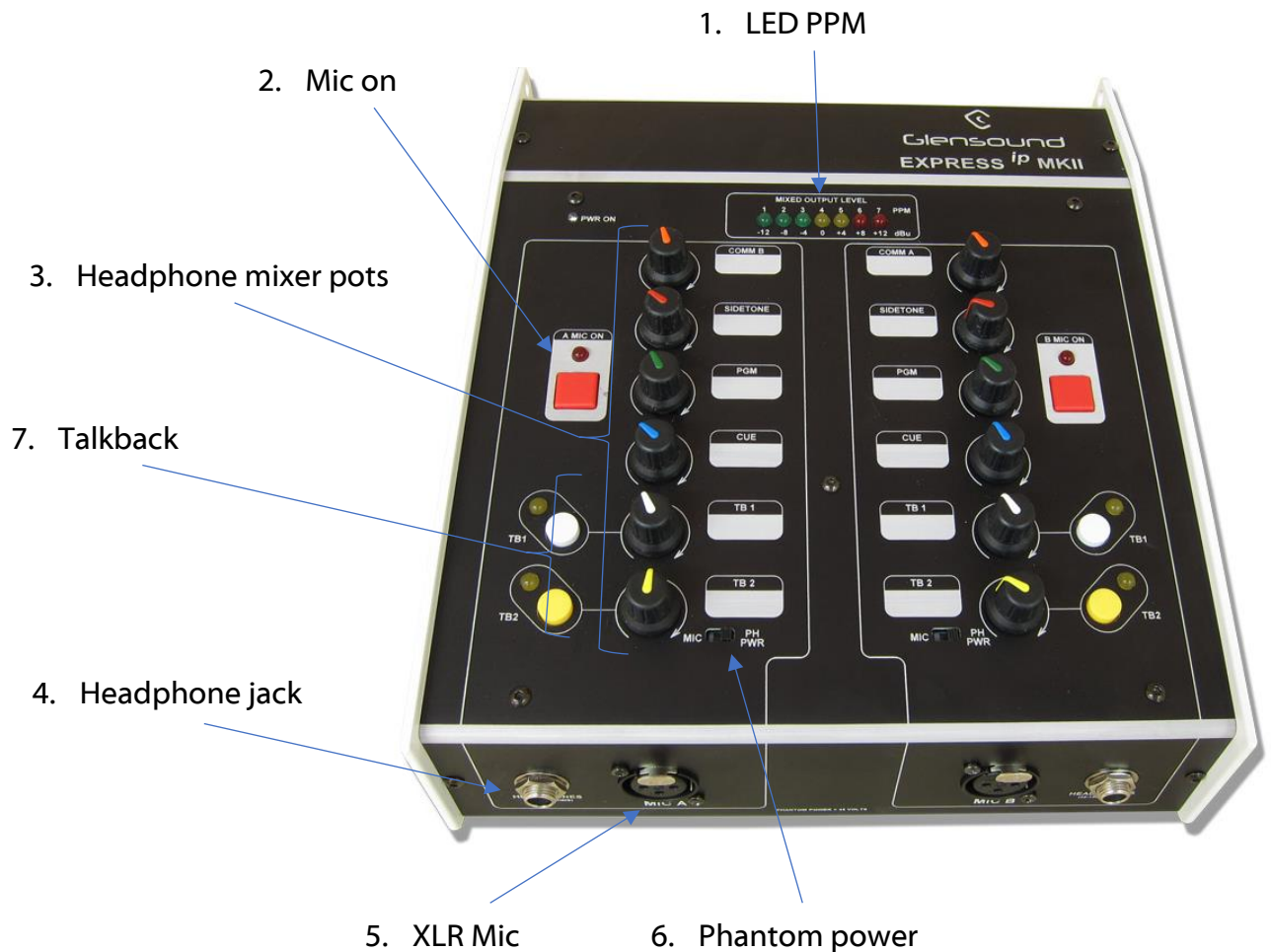

1. LED PPM Meter

The LED PPM Meter indicates the level of outgoing audio using the BBC 1 – 7 scale.

2. Mic on button

Pressing this button routes the microphone to the programme audio output. It is a latching button by default but can be set to be always on, or a momentary mute when held down. More information can be found on page 15.

3. Headphone mixer knobs

COMM B & A

This pot adjusts the mic audio level of the opposing channel for the headphone output.

SIDETONE

This pot adjusts the level of the mic audio for the headphone output.

PGM

This pot adjusts the headphone level of the PGM audio signal which can be sent via Dante.

CUE

This pot adjusts the headphone level of the CUE audio signal which can be sent via Dante.

TB 1

This pot adjusts the headphone level of the Talkback 1 audio signal which can be sent via Dante.

TB 2

This pot adjusts the headphone level of the Talkback 2 audio signal which can be sent via Dante.

4. **Talkback buttons**

Pressing either talkback 1 or talkback 2 mutes the microphone on the programme output, and routes the audio to the corresponding talkback output. The operation of this button is configurable into 4 modes (momentary, latching, intelligent, off). See page 15 for details.

5. **Headphone jack output**

The 6.35mm jack socket allows 35 – 1000Ω impedance headphones using A/B gauge plug.

6. **XLR Mic input**

The female 3 pin XLR socket allows microphones to be connected to the Express^{IP} MKII.

7. **Phantom power switch**

This switch turns on or off +48v phantom power input for use with condenser microphones.

EXPRESS^{IP} MKII REAR PANEL LAYOUT



1. Mix output selector

The Express^{IP} MKII has 4 outputs: 2 mics and 2 talkback circuits. This is the maximum number of channels sent to the Dante network. To provide a mixed output of both microphones, the B mic output can be changed to provide a mixed output using this switch.

2. Input status

The Express^{IP} MKII may be powered by either mains or Power over Ethernet (PoE) or both. The unit will accept both forms of power to allow for power redundancy.

3. Ethernet connector

The RJ45 ethernet connector allows the unit to be connected to a Dante audio network. The Express^{IP} MKII may be powered by PoE if the network connection it is connected to supplies it. This connection operates at 100Mbps speed.

4. Mains power input

The IEC mains plug accepts external AC voltages of 100 - 240 VAC +/- 10%. There is a non-accessible internal fuse for this input.

SIMPLIFIED BLOCK DIAGRAM

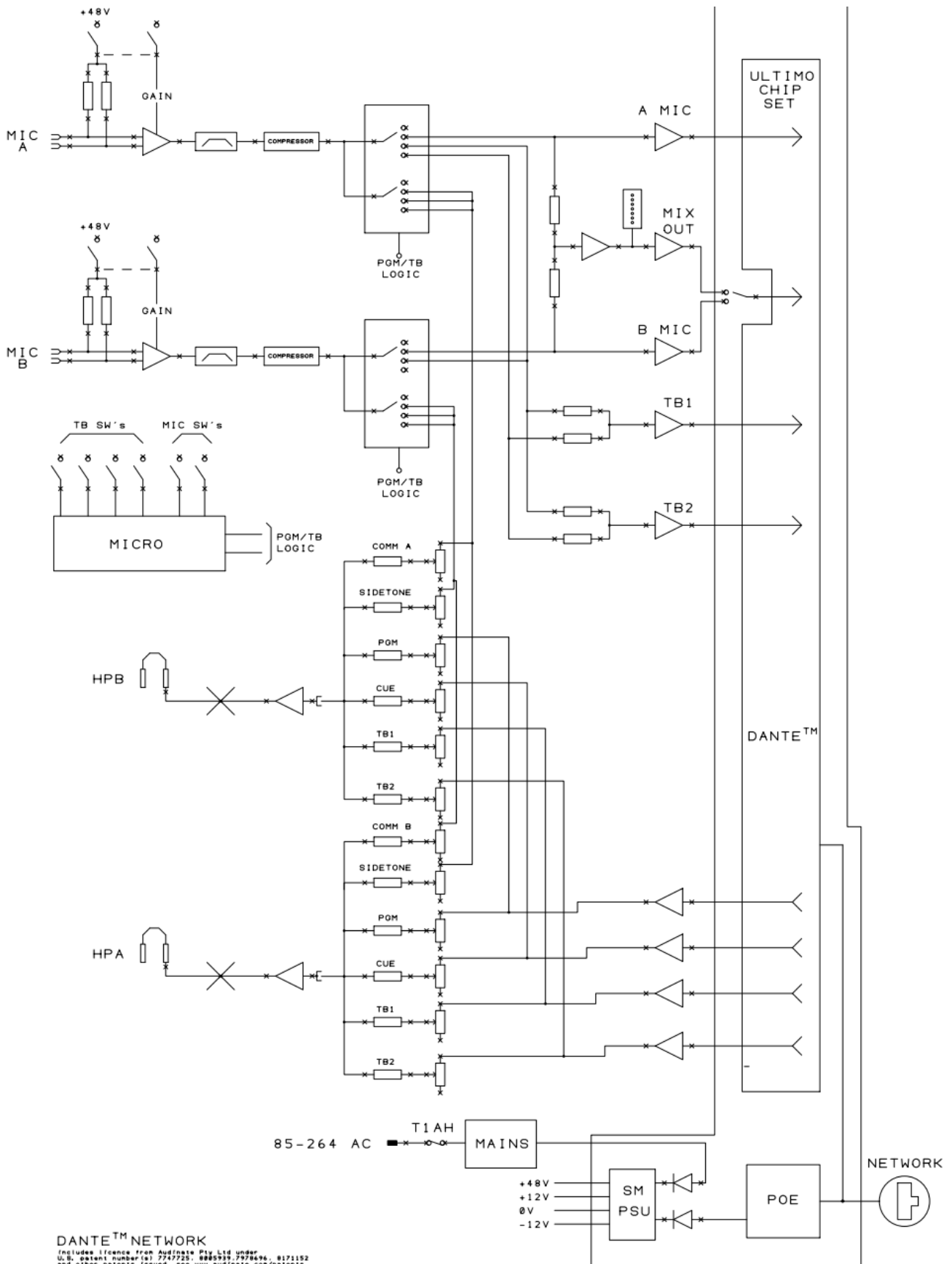

DANTE™ NETWORK
 Includes licence from Audinate Pty Ltd under
 U.S. patent number(s) 7747725, 8885939, 7978496, 8171152
 and other patents issued. See www.audinate.com/dante

CONNECTING THE EXPRESS^{IP} MKII TO A DANTE NETWORK

The Express^{IP} MKII is a network audio device utilizing the reliable and versatile Dante audio over IP protocol. Dante is a widely used proprietary system made by Audinate.

For full details of the power of Dante network audio and instructions for using it, visit www.audinate.com

Getting Dante Controller

If you are connecting the Express^{IP} MKII to a new Dante network the first thing you will need to do is to get the free Dante controller software from Audinate.

This can be downloaded by visiting Audinate's web site at www.audinate.com

Connecting Express^{IP} MKII To the Network

The Express^{IP} MKII can be connected to the network that you are going to use for your audio distribution simply by plugging in either, and, or any of the network connections on the front panel. Once connected to the network it will be possible to see the Express^{IP} MKII from within the Dante controller and route its' audio circuits.

Audio Over IP Network

We strongly recommend that you consider your network topology carefully and would not recommend sharing broadcast audio and general data on the same network.

For more details of audio over IP network structure please visit www.audinate.com

Running Dante Controller

At the time of writing this manual the Dante Controller looks as per the screenshot below:

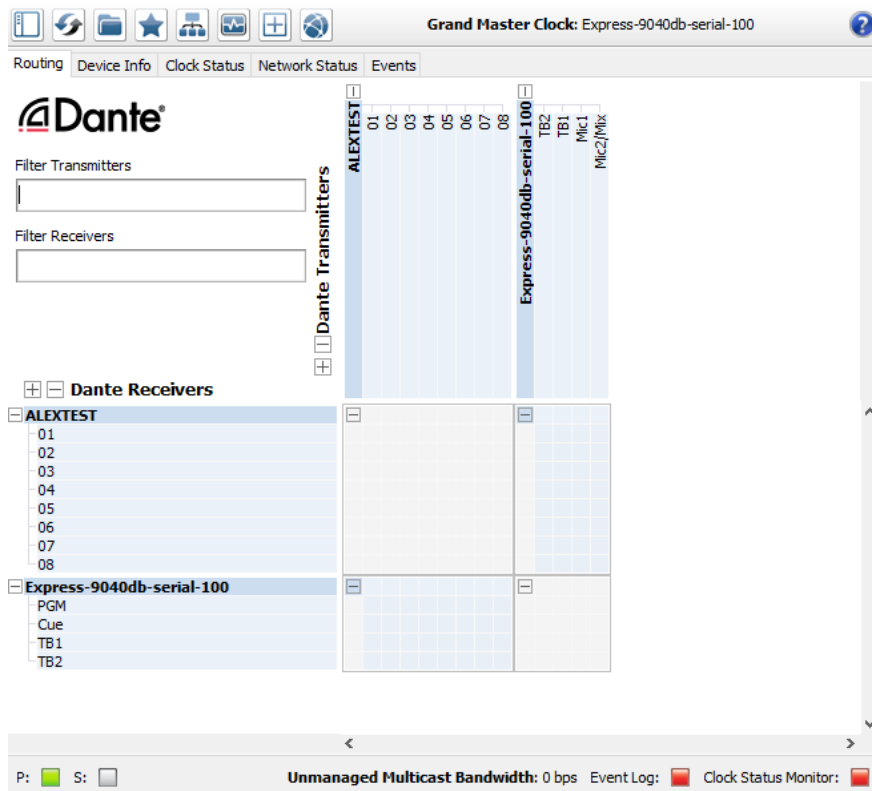

The Express^{IP} MKII will have been named at the factory during test to allow them to be identified by the Dante controller.

The format used for the factory name is:

'Express-9040db- serial-100'

Where 'Express-9040db' refers to the Glen sound product and MAC address and 'serial-100' refers to the its serial number.

Dante Controller TIP

If you have never run Dante controller before then make sure that on the bottom left of the Dante controllers' screen 'P' or 'S' is next to a green square as this indicates that it is connected to a network. By clicking 'P' or 'S' a pop up box opens to allow you to set what network interface the controller is using.

Device Not Showing Up In Dante Controller

If your Dante™ device does not show up in Dante™ Controller then the most likely issue is that the device's IP Address is not appropriate for your network.

- A) It maybe that the device is set to obtain an IP address automatically using DHCP (this is the default configuration) and your network is setup for fixed IP addresses only and does not have a DHCP server.
- B) It maybe that the device has had a fixed IP address assigned but that this address is not suitable for your network.

The solution to both scenarios is basically the same.

- 1) You must connect your Dante™ device directly to the Ethernet port of your computer using an Ethernet cable.
- 2) Make sure that your computer is set to 'Obtain an IP address automatically'
- 3) After a few minutes the Dante™ device should now appear in Dante™ Controller.
- 4) Double click the device name to open up device view.
- 5) Open up the 'Network Config' tab
- 6) Either turn on 'Obtain an IP Address Automatically' or correctly configure the 'Manually configure an IP Address' options for your network.
- 7) Click on 'Apply' to confirm the new settings, then disconnect the computer and reconnect the Dante™ device to your network.

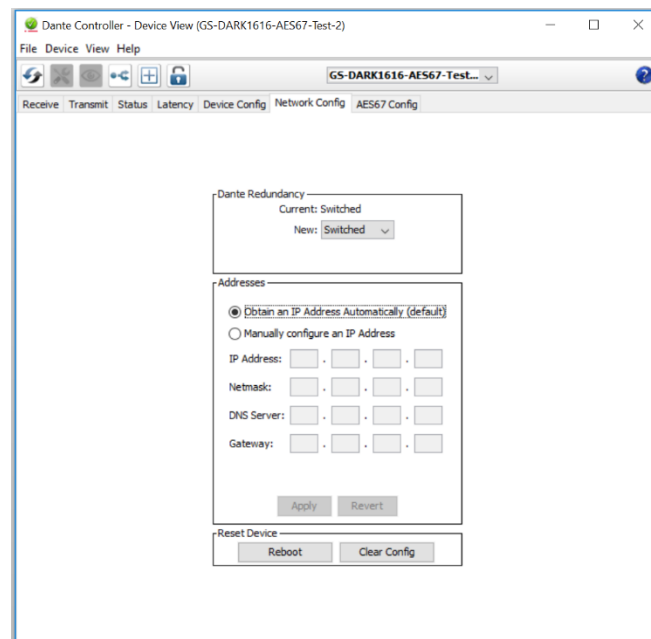

AES67 MODE

The Express IP uses a chipset from Audinate called the Ultimo for its network audio interface. Audinate are the company behind Dante™ and as such the chip's primary network audio protocol is Dante, however Audinate have enabled their chip to comply with AES67 and therefore the Express IP can be set to AES67 mode for interaction with other AES67 devices.

Please note however that Glensound are relying on Audinate's AES67 interface and are unfortunately not able to provide full AES67 support for the unit. AES67 support should be sought directly from Audinate.

1. Turning On AES67 Mode

If you want to use your Express IP on an AES67 network and it has not been set to AES67 mode then this can be set in Dante controller by double clicking the Paradiso to open the Device View window where you will find an AES67 tab to enable AES67 support.

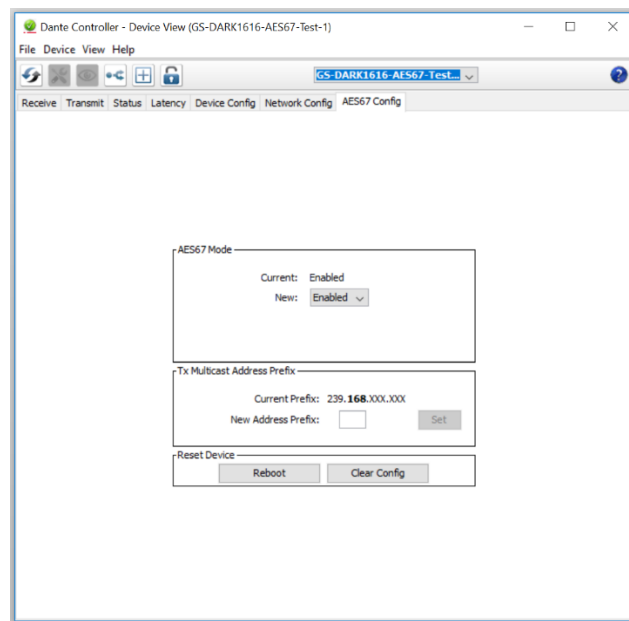

Once the AES67 drop down box has been enabled you'll have to reboot the Paradiso for the change to take effect. After the reboot go back to the AES67 tab and set the multicast prefix address to one that is suitable for your network

2. Sending AES67 Audio

To transmit AES67 audio to the network a multicast flow must first be setup. This is done by selecting the 'Create New Multicast Flow' Icon  in the Device View.

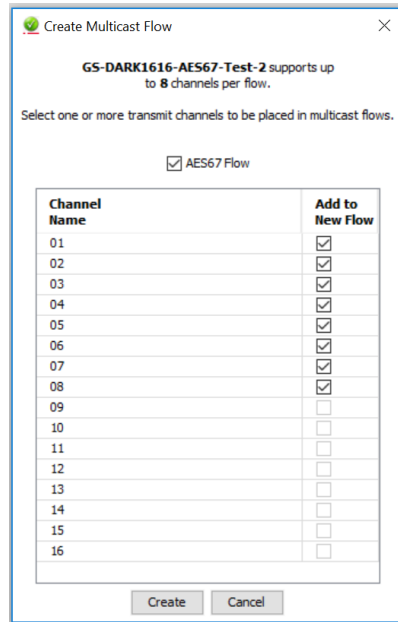

Tick the AES67 Flow check box, then select up to 8 channels to be included in the flow then click 'Create'

Once set the flows can be seen in the transmit tab of the device view.

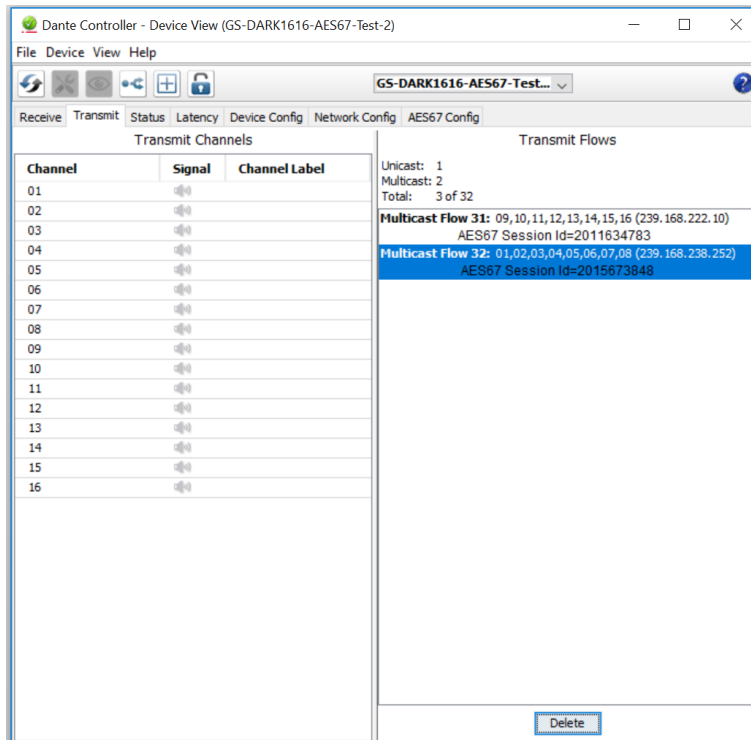

3. Receiving AES67 Audio

Once a compatible AES67 stream is detected on the network by Dante Controller the AES67 flows will appear in the Dante Transmitters section in the Routing tab.

4. AES67 Restrictions

AES67 flows can only be generated with the following constraints:

- Multicast Only
- Non-redundant
- Destination address in range 239.nnn.0.0 to 239.nnn.255.255 (239.nnn/16), port 5004
- 48kHz sampling rate
- 24 bit linear (L24) encoding
- 1 msec packet time
- Up to 8 channels per stream

Received AES67 flows have the following constraints:

- Multicast Only
- Non-redundant
- Destination address in range 239.nnn.0.0 to 239.nnn.255.255 (239.nnn/16), port 5004. Must match destination address range.
- 48kHz sampling rate
- L16 or L24 encoding
- 125usec, 250usec, 333usec, 1 msec packet time
- Up to 8 channels per stream

BUTTON FUNCTIONALITY (see also Interpreter's mode)

Two modes are available for the channel on/ off button and 4 modes for the talkback button operation. After mode changes the selected configuration will be stored, and reloaded when the Express^{ip} MKII is next switched on.

To enter programming mode of the Express^{ip} MKII:

1. Turn the Express^{ip} MKII off.
2. Hold down the 'A MIC ON' and 'A-TB1' buttons.
3. While holding the above buttons down turn the Express^{ip} MKII on.
4. Release the above buttons, you are now in programming mode.
5. While in programming mode the LEDs indicate the current setting.
6. To change a setting push the switch next to the LED.

After setting the desired mode, turn the Express^{ip} MKII off, your new settings will now be ready next time the unit is turned on.

LED INDICATION OF MODES

A & B MIC ON

Each main mic on switch can be programmed independently. Two modes are available, toggle on/ off or momentary off (cough).

LED	SWITCH OPERATION
OFF	Momentary (Cough)
ON	Toggle On/ Off

TALKBACK SWITCHES

The operation of all the talkback switches must be identical. There are 4 different possible settings.

TB1 LED	TB2 LED	All TB SWITCH OPERATION
OFF	OFF	Toggle & Momentary (quick tap to toggle, press & hold for momentary)
OFF	ON	Toggle
ON	OFF	Momentary
ON	ON	Disabled

INTERPRETER MODE

It is possible to set the Express ^{IP} MKII to operate as a simple two language interpreter's unit.

If set to interpreter mode then A and B Mic On buttons latch and toggle on/off. TB1 buttons also latch and toggle on/off.

The MIC A & B buttons interact with their own channel's TB1 button, whereby a channel's Mic On and TB1 (on) button cannot both be on at the same time and pressing one while the other is active will cause them to toggle.

The above means that Mix Out would be used for language one and TB1 out would be used for language two.

TB2 button still works as an off air talkback channel and pressing it will automatically turn off either Mic ON or TB1 (on) if they were on, on the channel that TB2 has been operated on.

To enable the Interpreter mode then:

1. Turn the Express ^{IP} MKII off.
2. Hold down the 'A MIC ON', 'A-TB1' and 'A-TB2' buttons.
3. Whilst holding down the above buttons turn the Express^{IP} MKII on.
4. Both MIC On LEDs will flash very quickly to indicate the programming has been accepted.
5. Turn the Express ^{IP} MKII off.

The next time you turn the unit on it will be in Interpreter mode.

To turn off the Interpreter mode, then follow the instructions to enter programming mode under 'button functionality' on the previous page.

MICROPHONE GAIN

The two microphone inputs of the Express^{IP} MKII have a fixed gain level.

To account for the higher gain level of condenser microphones; when the phantom power switch is turned on a -10dB pad is applied to the output.

If you have a microphone with an exceptionally high output level, the Express^{IP} MKII fixed gain level may not be low enough to avoid clipping.

It is possible to change the gain by removing two internal links. This process is semi-permanent, as it requires a sharp object to do it and a soldering iron to undo it.

Warning 

This process must only be undertaken by an approved technician. **DO NOT** attempt this procedure unless you know what you are doing. **Take extreme care.**

Equipment needed

1x M3 Screwdriver

1x A small precision sharp object – A scapel is best

Disconnect the Express^{IP} MKII from all power sources before continuing.

Procedure

To disassemble the Express^{IP} MKII, remove screws 1, 2, 3 and 4 from the bottom panel.

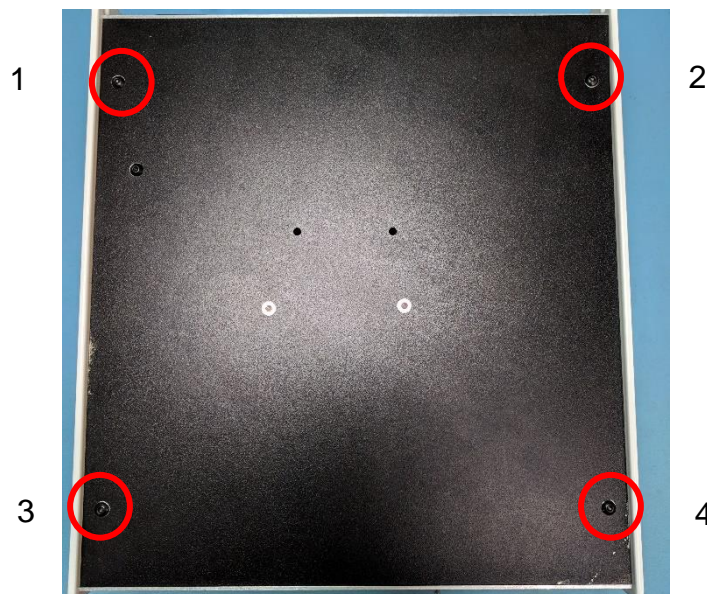

Remove the bottom panel.

You will be greeted with this view of the motherboard. The location of two links which must be removed are highlighted in red circles.

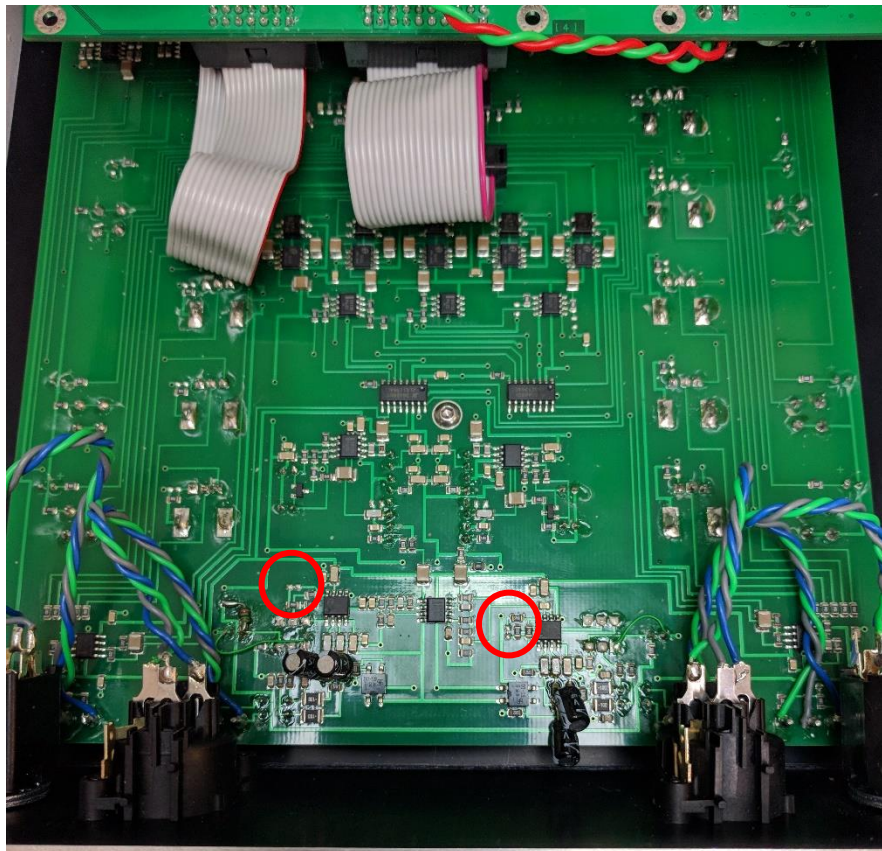

Figure 1 Interior view

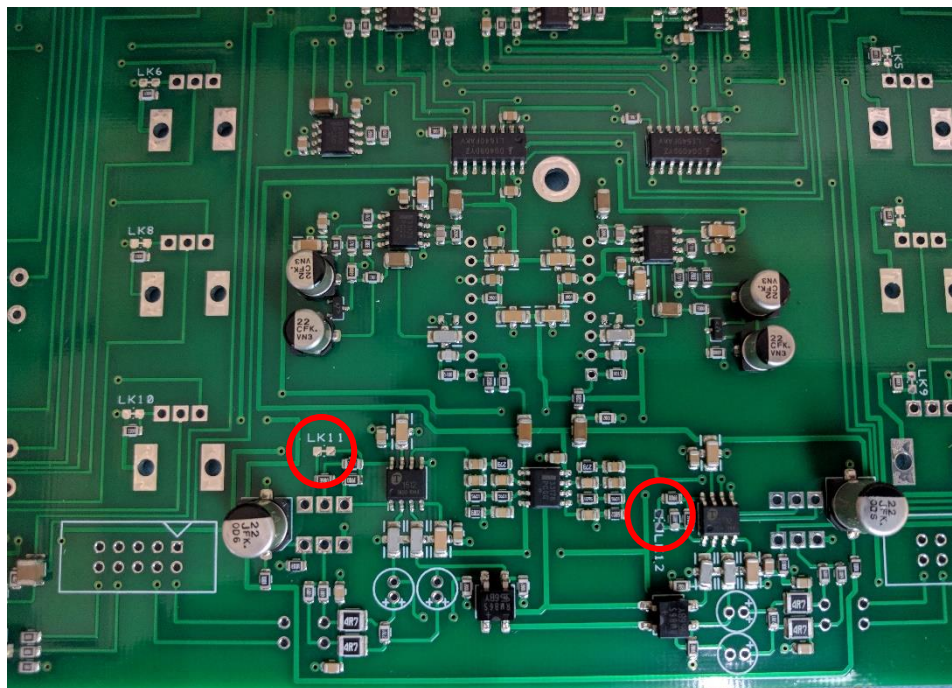

Figure 2 Links

Using a precise sharp object, cut the small track between the two pads for LK11 and LK12.

Take extreme care, cutting more than just the specific links may cause the Express^{IP} MKII to malfunction.

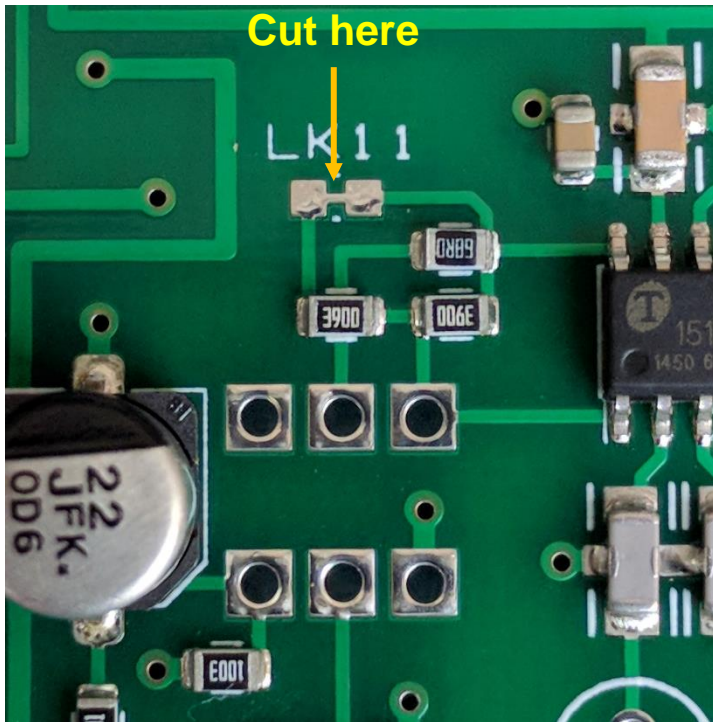

Figure 3 Link 1

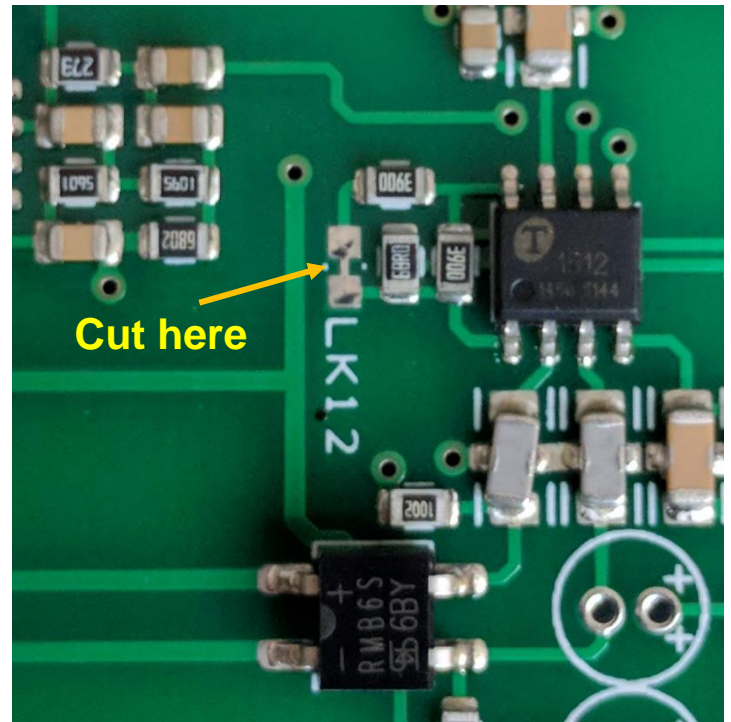

Figure 4 Link 2

Once the small track between the two pads has been cut, the gain will have been adjusted.

To revert this process, you must solder a bridge across one pad to the other to recreate the link.

Always ensure that the unit has been properly re-assembled and the bottom panel screwed securely in **before** powering up the Express^{IP} MKII.

MICROPHONE GAINS FOR 0dBu OUTPUTS

Dynamic Mic (Phantom power OFF) : 54dB

Condenser Mic Phantom power ON and internal link made: 44dB (factory default)

Condenser Mic Phantom power ON and internal link CUT: 37dB

WIRING INFORMATION

XLR & JACK Wiring

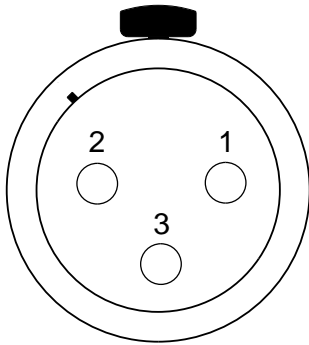

XLR SOCKET (FEMALE)

STANDARD XLR AUDIO PINOUTS:

1: Ground/ Earth

2: INPHASE/ POSITIVE/ MIC +

3: MATE/ NEGATIVE/ MIC -

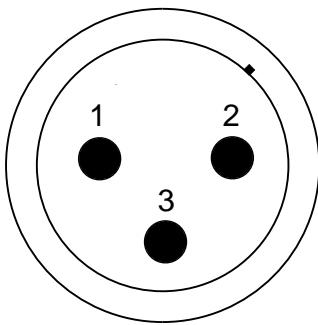

XLR PLUG (MALE)

STANDARD HEADPHONE WIRING:

TIP: A/ LEFT Ear

RING: B/ RIGHT Ear

SLEEVE: Common/ Earth

